

LED FLOOD LIGHTS

V-TAC's LED Floodlights are ideal for lighting Driveways, Gardens and Buildings. These energy efficient lights emit Bright, Vibrant Light and are an eco friendly replacement for traditional Halogen Floodlights and Metal Halide fixtures

PRODUCT FEATURES

- Available in White , Warm White and RGB Light output option
- Available from 10W up to 600W
- Premium Quality Aluminium Alloy body
- Corrosion Resistant
- Fascia glass sealed with SILICONE RUBBER ensuring superior waterproof / airtight performance
- High Power LED chip
- Built in constant current driver
- Better Power Savings
- Built in Power supply, No external ballast required

APPLICATIONS

- Widely used for Lighting Driveways, Gardens & Buildings, Commercial Bill Boards & Hoardings, Plazas, Sports Grounds & Parking Lots





10W
VT-4714

5655 3000K Warmwhite
5656 4500K Daywhite
5657 6000K White

18W
EQUIVALENT

ITALIAN
DESIGN

IP65
TESTED & APPROVED



20W
VT-4724

5658 3000K Warmwhite
5659 4500K Daywhite
5660 6000K White

36W
EQUIVALENT



30W
VT-4734

5661 3000K Warmwhite
5662 4500K Daywhite
5663 6000K White

54W
EQUIVALENT



50W
VT-4754

5664 3000K Warmwhite
5665 4500K Daywhite
5666 6000K White

90W
EQUIVALENT

Model No	VT-4714	VT-4724	VT-4734	VT-4754
Watts	10W	20W	30W	50W
EQ. Watts	18W	36W	54W	90W
Voltage/Frequency	AC: 200-240V, 50Hz	AC: 200-240V, 50Hz	AC: 200-240V, 50Hz	AC: 200-240V, 50Hz
Luminous Flux	800lm	1600lm	2400lm	4000lm
CRI	>70	>70	>70	>70
PF	>0.9	>0.9	>0.9	>0.9
Beam Angle	85'D	90'D	90'D	100'D
Color of Fixture	Grey	Grey	Grey	Grey
Body Type	Die cast Aluminum	Die cast Aluminum	Die cast Aluminum	Die cast Aluminum
IP Rating	IP65	IP65	IP65	IP65
Dimension	137 x 87 x 60mm	218 x 142 x 60mm	274 x 188 x 73mm	335 x 239 x 120mm



EAN Code 3000K
EAN Code 4500K
EAN Code 6000K

3800157603027
3800157603034
3800157603041



3800157603058
3800157603065
3800157603072



3800157603089
3800157603096
3800157603102



3800157603119
3800157603126
3800157603133



100W VT-47104

5667 3000K Warmwhite
5668 4500K Daywhite
5669 6000K White



180W
EQUIVALENT

150W VT-47154

5670 3000K Warmwhite
5671 4500K Daywhite
5672 6000K White



270W
EQUIVALENT

200W VT-47204

5673 3000K Warmwhite
5674 4500K Daywhite
5675 6000K White



360W
EQUIVALENT

Model No	VT-47104	VT-47154	VT-47204
Watts	100W	150W	200W
EQ. Watts	180W	270W	360W
Voltage/Frequency	AC: 200-240V, 50Hz	AC: 200-240V, 50Hz	AC: 200-240V, 50Hz
Luminous Flux	8000lm	12000lm	16000lm
CRI	>70	>70	>70
PF	>0.9	>0.9	>0.9
Beam Angle	100°D	100°D	110°D
Color of Fixture	Grey	Grey	Grey
Body Type	Die cast Aluminum	Die cast Aluminum	Die cast Aluminum
IP Rating	IP65	IP65	IP65
Dimension	405 x 288 x 130mm	480 x 330 x 160mm	535 x 355 x 170mm



EAN Code 3000K 3800157603140
EAN Code 4500K 3800157603157
EAN Code 6000K 3800157603164



3800157603171
3800157603188
3800157603195



3800157603201
3800157603218
3800157603225



10W
VT-4810

N/A 5769 3000K Warmwhite
5770 / 5733 4500K Daywhite
5867 / 5734 6000K White



Model No	VT-4810
Watts	10W
EQ. Watts	50W
Voltage/Frequency	AC:100-240V,50/60Hz
Luminous Flux	800lm
CRI	>70
PF	>0.95
Beam Angle	100'D
Color of Fixture	White
Body Type	Die cast Aluminum
IP Rating	IP65
Dimension	132 x 117 x 36mm

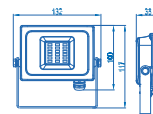
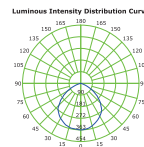
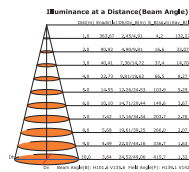

EAN Code 3000K N/A
EAN Code 4500K 3800157606905
EAN Code 6000K 3800157606912



10W
VT-4810

5720 3000K Warmwhite
5721 4500K Daywhite
5722 6000K White

**SUPER
SLIM**

**HIGH POWER
SMD**

Model No	VT-4810
Watts	10W
EQ. Watts	50W
Voltage/Frequency	AC:100-240V,50/60Hz
Luminous Flux	800lm
CRI	>70
PF	>0.95
Beam Angle	100°D
Color of Fixture	Grey & Black
Body Type	Die cast Aluminum
IP Rating	IP65
Dimension	132 x 117 x 36mm

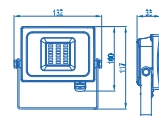
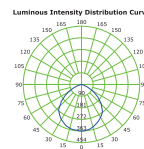
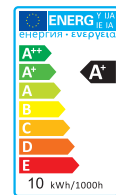
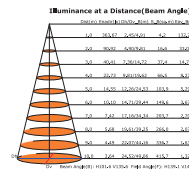

EAN Code 3000K
EAN Code 4500K
EAN Code 6000K

3800157605120
3800157605137
3800157605144

SLIM LED FLOODLIGHT

like never seen before!



20W VT-4820-1

5676 3000K Warmwhite
5677 4500K Daywhite
5678 6000K White

30W VT-4830-1

5679 3000K Warmwhite
5680 4500K Daywhite
5681 6000K White

50W VT-4850-1

5682 3000K Warmwhite
5683 4500K Daywhite
5684 6000K White

100W VT-48100-1

5685 3000K Warmwhite
5686 4500K Daywhite
5687 6000K White

Model No	VT-4820-1	VT-4830-1	VT-4850-1	VT-48100-1
Watts	20W	30W	50W	100W
EQ. Watts	100W	150W	250W	500W
Voltage/Frequency	AC:100-240V,50/60Hz	AC:100-240V,50/60Hz	AC:100-240V,50/60Hz	AC:100-240V,50/60Hz
Luminous Flux	1600lm	2400lm	4000lm	8000lm
CRI	>70	>70	>70	>70
PF	>0.95	>0.95	>0.95	>0.95
Beam Angle	100'D	100'D	100'D	100'D
Color of Fixture	White	White	White	White
Body Type	Die cast Aluminum	Die cast Aluminum	Die cast Aluminum	Die cast Aluminum
IP Rating	IP65	IP65	IP65	IP65
Dimension	182 x 142 x 36mm	233 x 188 x 36mm	296 x 225 x 40mm	353 x 268 x 46mm



EAN Code 3000K
EAN Code 4500K
EAN Code 6000K

3800157603355
3800157603362
3800157603379



3800157603386
3800157603393
3800157603409



3800157603416
3800157603423
3800157603430



3800157603447
3800157603454
3800157603461

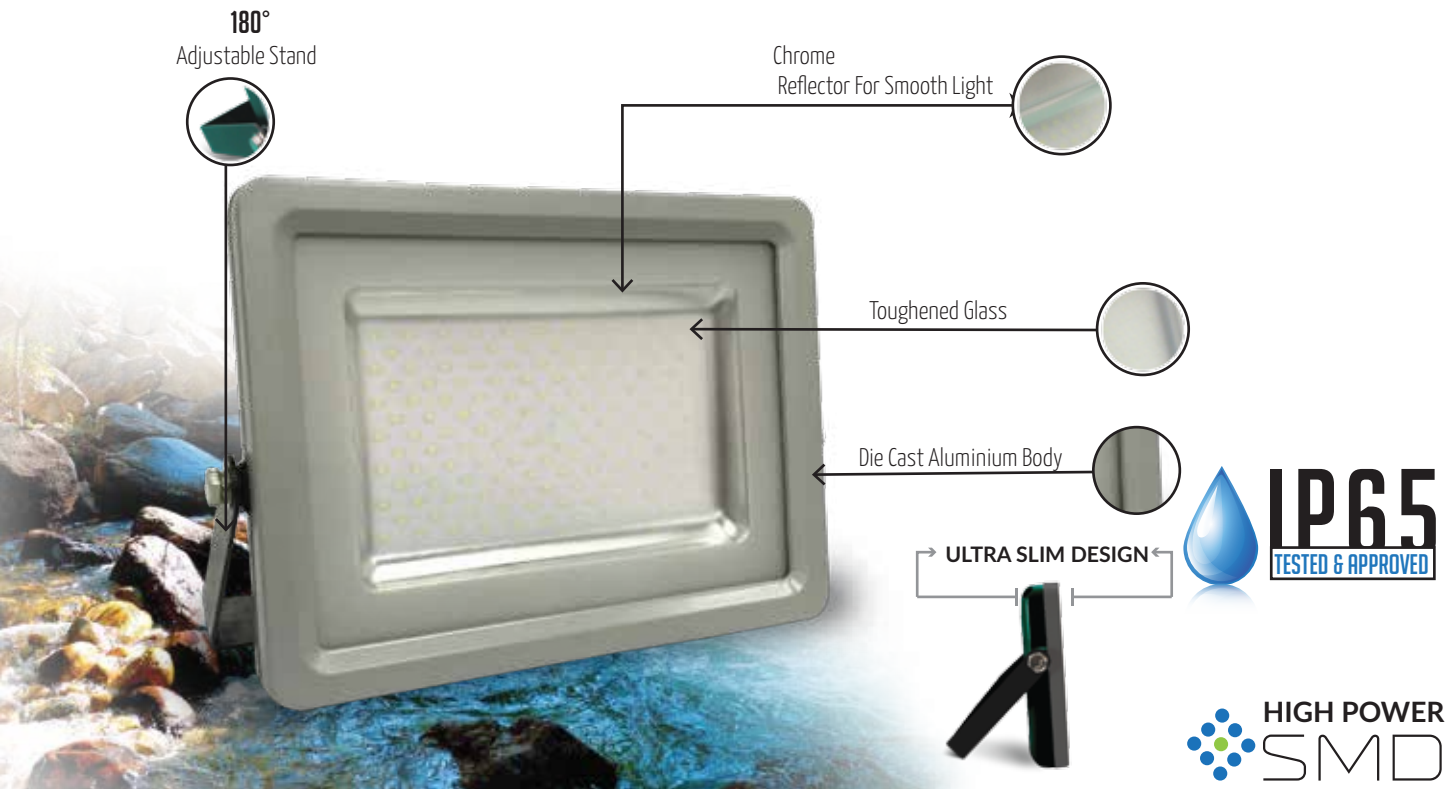

20W VT-4820

5868 / 5703 3000K Warmwhite
5759 / 5704 4500K Daywhite
5869 / 5705 6000K White

30W VT-4830

5706 3000K Warmwhite
5707 4500K Daywhite
5708 6000K White

50W VT-4850

5762 / 5709 3000K Warmwhite
5763 / 5710 4500K Daywhite
5764 / 5711 6000K White

100W VT-48100

5765 / 5712 3000K Warmwhite
5766 / 5713 4500K Daywhite
5767 / 5714 6000K White

Model No	VT-4820	VT-4830	VT-4850	VT-48100
Watts	20W	30W	50W	100W
EQ. Watts	100W	150W	250W	500W
Voltage/Frequency	AC:100-240V,50/60Hz	AC:100-240V,50/60Hz	AC:100-240V,50/60Hz	AC:100-240V,50/60Hz
Luminous Flux	1600lm	2400lm	4000lm	8000lm
CRI	>70	>70	>70	>70
PF	>0.95	>0.95	>0.95	>0.95
Beam Angle	100°D	100°D	100°D	100°D
Color of Fixture	Grey & Black	Grey & Black	Grey & Black	Grey & Black
Body Type	Die cast Aluminum	Die cast Aluminum	Die cast Aluminum	Die cast Aluminum
IP Rating	IP65	IP65	IP65	IP65
Dimension	182 x 142 x 36mm	233 x 188 x 36mm	296 x 225 x 40mm	353 x 268 x 46mm



EAN Code 3000K
EAN Code 4500K
EAN Code 6000K

3800157604444
3800157604451
3800157604468

3800157604475
3800157604482
3800157604499

3800157604505
3800157604512
3800157604529

3800157604536
3800157604543
3800157604550

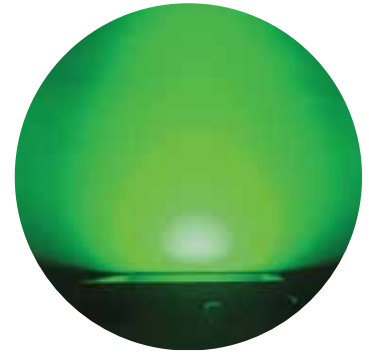

20W
VT-4820

5760 / 5718 Green



Model No	VT-4820
Watts	20W
EQ. Watts	100W
Voltage/Frequency	AC:100-240V,50/60Hz
Luminous Flux	1600lm
CRI	>70
PF	>0.95
Beam Angle	100'D
Color of Fixture	Grey & Black
Body Type	Die cast Aluminum
IP Rating	IP65
Dimension	182 x 142 x 36mm



EAN Code Green

3800157604970

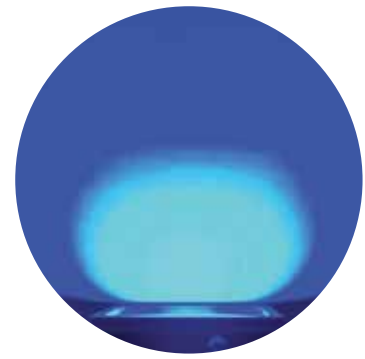

20W
VT-4820

5719 Blue



Model No	VT-4820
Watts	20W
EQ. Watts	100W
Voltage/Frequency	AC:100-240V,50/60Hz
Luminous Flux	1600lm
CRI	>70
PF	>0.95
Beam Angle	100'D
Color of Fixture	Grey & Black
Body Type	Die cast Aluminum
IP Rating	IP65
Dimension	182 x 142 x 36mm



EAN Code Blue

3800157604987



150W
VT-48152

N/A 3000K Warmwhite
 5739 500K Daywhite
 5740 6000K White



Model No	VT-48152
Watts	150W
EQ. Watts	750W
Voltage/Frequency	AC:100-240V,50/60Hz
Luminous Flux	12000lm
CRI	>70
PF	>0.95
Beam Angle	120°D
Color of Fixture	Grey & Black
Body Type	Die cast Aluminum
IP Rating	IP65
Dimension	423 x 352x 60mm

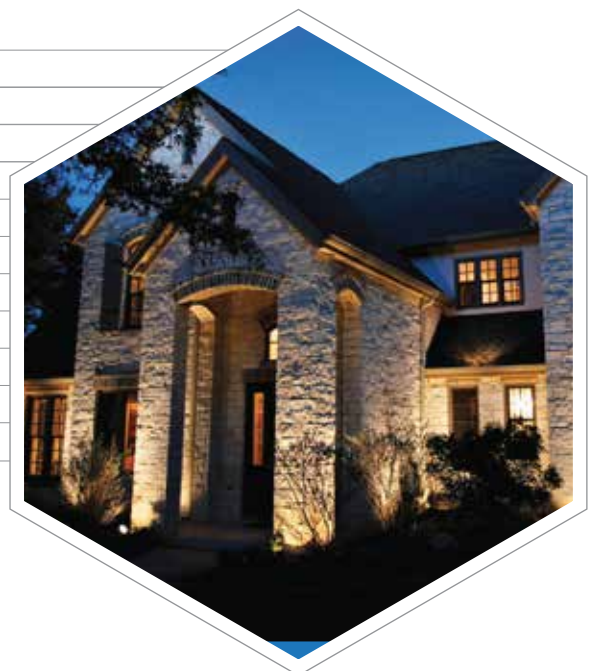

EAN Code 3000K
 EAN Code 4500K
 EAN Code 6000K

N/A
 3800157607711
 3800157607728



200W
VT-48202

N/A / N/A 3000K Warmwhite
5873 / 5729 4500K Daywhite
5874 / 5730 6000K White



Model No	VT-48202
Watts	200W
EQ. Watts	1000W
Voltage/Frequency	AC:100-240V,50/60Hz
Luminous Flux	16000lm
CRI	>70
PF	>0.9
Beam Angle	100°D
Color of Fixture	Grey & Black
Body Type	Die cast Aluminum
IP Rating	IP65
Dimension	423 x 352 x 60 mm



EAN Code 3000K
EAN Code 4500K
EAN Code 6000K

N/A
3800157606127
3800157606134





300W
VT-48302

N/A 3000K Warmwhite
5731 4500K Daywhite
5732 6000K White



Model No	VT-48302
Watts	300W
EQ. Watts	1500W
Voltage/Frequency	AC:100-240V,50/60Hz
Luminous Flux	24000lm
CRI	>70
PF	>0.9
Beam Angle	100'D
Color of Fixture	Grey & Black
Body Type	Die cast Aluminum
IP Rating	IP65
Dimension	532 x 443 x 70 mm



EAN Code 3000K
EAN Code 4500K
EAN Code 6000K

N/A
3800157606141
3800157606158





800
LUMENS

10W IP44

VT-4810-1 PIR

5746 3000K Warmwhite
5747 4500K Daywhite
5748 6000K White



1600
LUMENS

20W IP44

VT-4820-1 PIR

5756 3000K Warmwhite
5749 4500K Daywhite
5750 6000K White



PIR
SENSOR
SERIES



2400
LUMENS

30W IP44

VT-4830-1 PIR

5757 3000K Warmwhite
5751 4500K Daywhite
5752 6000K White



4000
LUMENS

50W IP44

VT-4850-1 PIR

5758 3000K Warmwhite
5753 4500K Daywhite
5754 6000K White



Model No	VT-4810-1 PIR	VT-4820-1 PIR	VT-4830-1 PIR	VT-4850-1 PIR
Watts	10W	20W	30W	50W
EQ. Watts	50W	100W	150W	250W
Voltage/Frequency	AC:100-240V,50/60Hz	AC:100-240V,50/60Hz	AC:100-240V,50/60Hz	AC:100-240V,50/60Hz
Luminous Flux	800lm	1600lm	2400lm	4000lm
CRI	>70	>70	>70	>70
PF	>0.95	>0.95	>0.95	>0.95
Beam Angle	100'D	100'D	100'D	100'D
Color of Fixture	White	White	White	White
Body Type	Die cast Aluminum	Die cast Aluminum	Die cast Aluminum	Die cast Aluminum
IP Rating	IP44	IP44	IP44	IP44
Dimension	133x178x47mm	185x211x50mm	237x255x51mm	300x272x55mm

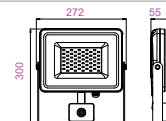
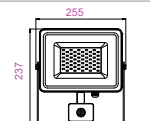
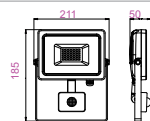
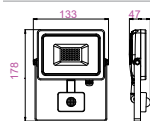

EAN Code 3000K
EAN Code 4500K
EAN Code 6000K

3800157608206
3800157608213
3800157608220

3800157611688
3800157608862
3800157608879

3800157611695
3800157608886
3800157608893

3800157611701
3800157608909
3800157608916



800
LUMENS

IP44

10W
VT-4810 PIR

5723 3000K Warmwhite
5724 4500K Daywhite
5725 6000K White



1600
LUMENS

IP44

20W
VT-4820 PIR

5697 3000K Warmwhite
5698 4500K Daywhite
5715 6000K White



PIR
SENSOR
SERIES



2400
LUMENS

IP44

30W
VT-4830 PIR

5699 3000K Warmwhite
5700 4500K Daywhite
5716 6000K White



4000
LUMENS

IP44

50W
VT-4850 PIR

5701 3000K Warmwhite
5702 4500K Daywhite
5717 6000K White



Model No	VT-4810 PIR	VT-4820 PIR	VT-4830 PIR	VT-4850 PIR
Watts	10W	20W	30W	50W
EQ. Watts	50W	100W	150W	250W
Voltage/Frequency	AC:100-240V,50/60Hz	AC:100-240V,50/60Hz	AC:100-240V,50/60Hz	AC:100-240V,50/60Hz
Luminous Flux	800lm	1600lm	2400lm	4000lm
CRI	>70	>70	>70	>70
PF	>0.95	>0.95	>0.95	>0.95
Beam Angle	100°D	100°D	100°D	100°D
Color of Fixture	White	White	White	White
Body Type	Die cast Aluminum	Die cast Aluminum	Die cast Aluminum	Die cast Aluminum
IP Rating	IP44	IP44	IP44	IP44
Dimension	Black	Black	Black	300x272x55mm

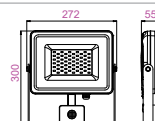
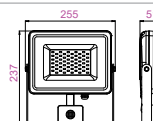
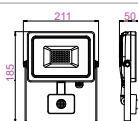
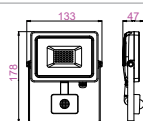

EAN Code 3000K
EAN Code 4500K
EAN Code 6000K

3800157608206
3800157608213
3800157608220

3800157604338
3800157604345
3800157604949

3800157604352
3800157604369
3800157604956

3800157604376
3800157604383
3800157604963



10W
VT-4710 5370



10W
VT-4710 5369



20W
VT-4822

N/A 3000K Warmwhite
5692 4500K Daywhite
5735 6000K White



Model No	VT-4710 RGB	VT-4710 RGB	VT-4822
Watts	10W	10W	20W
EQ. Watts	40W	40W	80W
Voltage/Frequency	AC: 90-240V, 50/60Hz	AC: 90-240V, 50/60Hz	AC:85-265V,50/60Hz
Luminous Flux	600lm	600lm	1600lm
CRI	> 80	> 80	/
PF	> 0.8	> 0.8	>0.95
Beam Angle	120°D	120°D	120°D
Color of Fixture	Grey	Grey	Green
Body Type	Aluminum	Aluminum	Die cast Aluminum
IP Rating	IP65	IP65	IP54
Dimension	115 x 87 x 85mm	115 x 87 x 85mm	208 x 204 x 355mm



EAN Code RGB

3800230624567

3800230624550

N/A
3800157603515
3800157606929



10W
VT-4711

5894
Radio
Remote Controller

800
LUMENS

40W
EQUIVALENT



10W
VT-4711

5895
Radio
Remote Controller

800
LUMENS

40W
EQUIVALENT



30W
VT-4732

5755



50W
VT-4752

5691



Model No	VT-4711 RGB	VT-4711 RGB	VT-4732 RGB	VT-4752 RGB
Watts	10W	10W	30W	50W
EQ. Watts	40W	40W	150W	250W
Voltage/Frequency	AC:220-240V,50/60Hz	AC:220-240V,50/60Hz	AC: 90-240V, 50/60Hz	AC:100-240V,50/60Hz
Luminous Flux	800lm	800lm	240lm	4000lm
CRI	>70	>70	>70	>70
PF	>0.95	>0.95	>0.95	>0.95
Beam Angle	100'D	100'D	120'D	120'D
Color of Fixture	White	White	Grey	Grey
Body Type	Die cast Aluminum	Die cast Aluminum	Die cast Aluminum	Die cast Aluminum
IP Rating	IP65	IP65	IP65	IP65
Dimension	115x87x85mm	115x87x85mm	227 x 130 x 205mm	227 x 130 x 205mm



EAN Code RGB

3800157617512

3800157617529

3800230624574

3800157603508



200W N/A 3000K Warmwhite
VT-47200 5644 4500K Daywhite
5385 6000K White



Model No	VT-47200
Watts	200W
EQ. Watts	800W
Voltage/Frequency	AC:90-240V,50/60Hz
Luminous Flux	16000lm
CRI	> 70
PF	> 0.9
Beam Angle	120'D
Color of Fixture	Grey
Body Type	Die cast Aluminum
IP Rating	IP65
Dimension	380 x 340 x 120mm



EAN Code 3000K
EAN Code 4500K
EAN Code 6000K

N/A
3800157600767
3800230627421

Illuminance at a Distance (Beam Angle)

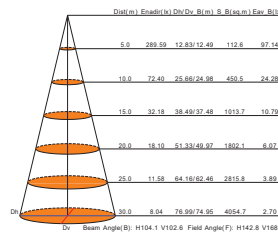

Luminous Intensity Distribution Curve

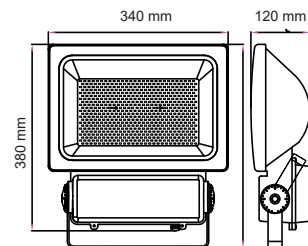
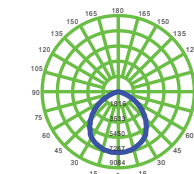



300W
VT-47300

N/A 3000K Warmwhite
5693 4500K Daywhite
5386 6000K White

HIGH POWER
SMD

Model No	VT-47300
Watts	300W
EQ. Watts	1200W
Voltage/Frequency	AC:90-240V,50/60Hz
Luminous Flux	24000lm
CRI	> 70
PF	> 0.9
Beam Angle	120°D
Color of Fixture	Grey
Body Type	Die cast Aluminum
IP Rating	IP65
Dimension	430 x 410 x 145mm



EAN Code 3000K
EAN Code 4500K
EAN Code 6000K

N/A
3800157603652
3800230627438

Illuminance at a Distance (Beam Angle)

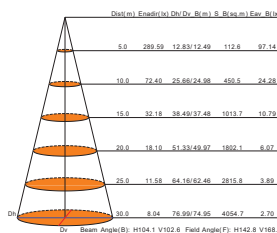

Luminous Intensity Distribution Curve

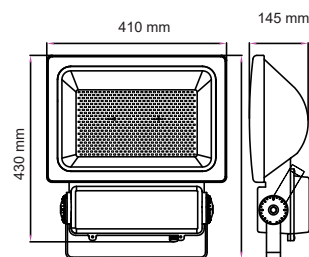
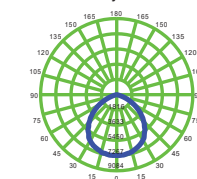



400W
VT-47400

N/A 3000K Warmwhite
5694 4500K Daywhite
5649 6000K White



HIGH POWER
SMD

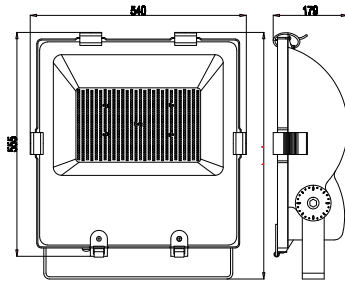

500W
VT-47500

N/A 3000K Warmwhite
5695 4500K Daywhite
5696 6000K White



Model No

Watts
EQ. Watts
Voltage/Frequency
Luminous Flux
CRI
PF
Beam Angle
Color of Fixture
Body Type
IP Rating
Dimension

VT-47400

400W
1600W
AC:90-240V,50/60Hz
32000lm
> 70
> 0.9
120'D
Black
Die cast Aluminum
IP65
555 x 540 x 179mm

VT-47500

500W
2000W
AC:100-240V,50/60Hz
40000lm
>70
>0.95
120'D
Black
Die cast Aluminum
IP65
555 x 540 x 179mm



EAN Code 3000K
EAN Code 4500K
EAN Code 6000K

N/A
3800157603669
3800157601269

N/A
3800157603805
3800157603812



600W
VT-47600

N/A 3000K Warmwhite
5726 4500K Daywhite
N/A 6000K White



Model No	VT-47600
Watts	600W
EQ. Watts	3000W
Voltage/Frequency	AC:100-240V,50/60Hz
Luminous Flux	48000lm
CRI	>80
PF	>0.9
Beam Angle	120'D
Color of Fixture	Black
Body Type	Die cast Aluminum
IP Rating	IP65
Dimension	540x555x625mm



EAN Code 3000K
EAN Code 4500K
EAN Code 6000K

N/A
3800157605854
N/A

Illuminance at a Distance (Beam Angle)

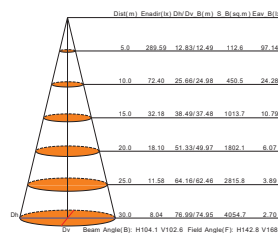

Luminous Intensity Distribution Curve

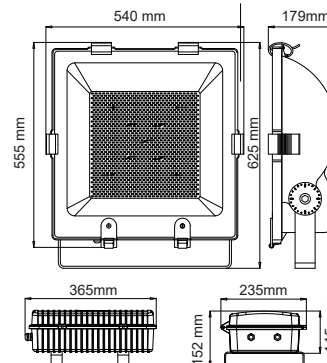
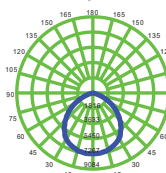



18W

VT-4818

N/A 3000K Warmwhite
N/A 4500K Daywhite
5745 6000K White



Model No	VT-4818
Power	AC100-240V
Output	18W
Detection Range	0-12M
Detect Angle	180°
Delay Time	0-30S
LED	42PCS 0.2W
Lumen	600LM
Material	ABS +Aluminum
Image sensor	1/4 " 1Megapixel CMOS
Video Compression	H.264 /MJPEG dual video stream
Max Image Resolution	1280*720
Pixcel	1 million pixels
Size	270x 170 x 170mm



EAN Code 3000K N/A
EAN Code 4500K N/A
EAN Code 6000K 3800157608268

Accessories LED Floodlights

TRIPOD STAND FOR FLOOD LIGHTS (YELLOW)



Model No	VT-778
SKU Code	9104
EAN Code	3800230626202



TRIPOD STAND FOR FLOOD LIGHTS (BLACK)

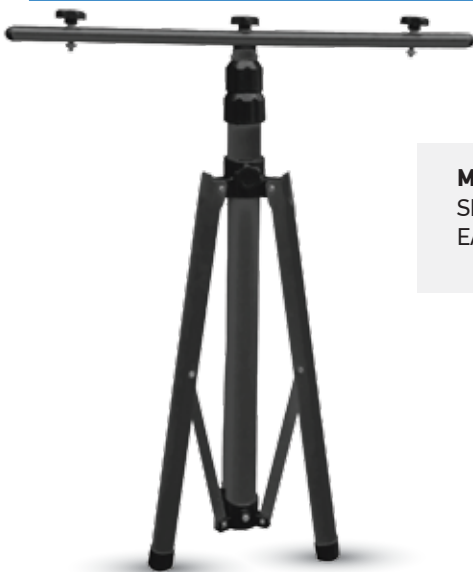

Model No	VT-778
SKU Code	9546
EAN Code	3800157604925



Accessories LED Floodlights

WATERPROOF BOX TERMINAL BLOCK

Model No VT-729
SKU Code 3621
EAN Code 3800157607735

Can work for
wire 3x0.75mm².
wire 3x1 .0rnm²
Inside Terminal block

**ALSO AVAILABLE
IN WHITE BODY**

SKU Code 5896
EAN Code 3800157619196



Model No VT-7224
SKU Code 3578
EAN Code 3800157605335

Can work for
wire 3x0.75mm².
wire 3x1 .0rnm²
wire 3x1 .5mm²

**ALSO AVAILABLE
IN WHITE BODY**

SKU Code 5897
EAN Code 3800157619202



**BILLBOARD STAND
FOR FLOOD LIGHTS**

Model No VT-794
SKU Code 3623
EAN Code 3800157607810

85CM

SUITABLE FOR:
10W - 20W - 30W - 50W



Model No VT-793
SKU Code 3622
EAN Code 3800157607803

87CM

SUITABLE FOR:
70W - 100W - 120W - 150W - 200W

