



LED STRIP LIGHTS

Add an extensive array of lights and colors to any setting or interior, rejuvenate and transform the ambience of any environment at the flick of a switch with V-TAC's LED Strip Light Series. Easy installation with minimal space requirement makes this the right choice for Restaurants, Auditoriums and Meeting Rooms etc.

PRODUCT FEATURES

- LED strip is a low Voltage flexible Ribbon available in 12v
- Flexible & easy installation
- Exceptionally low power consumption
- Multiple visual effects in unending colours and shades
- Available in 12V and 220V with different color range from Warm White to RGB
- Available in IP20 and IP65 rating
- Available in 8mm or 10mm width
- Available in 1 or 1.5 meter rigid bar options with different options of Aluminium Profiles

APPLICATIONS

- Ideal for illuminating Borders, Edges, Cabinets, Bars and any area with limited space for installation
- Safe to use in most of the application



LED STRIP LIGHTS
3528 SERIES



2835-NON WP
240 LED/M

3000 LM/LED
HIGH LUMEN

CRI >80



LED Type	2835
Watt/M	18W
Current/M	1.5A
Voltage	12V DC
LED Qty	240
LM/LED	3000
Beam Angle	120°
IP Rating	IP20
Width	8mm

**2835-NON WP
240 LED/M**

Color	SKU Code	EAN Code
Warm White	2164	3800157610117
White	2165	3800157610124
Daywhite	2166	3800157610131

**2835-NON WP
204 LED/M**

Color	SKU Code	EAN Code
Warm White	2461	3800157612234
White	2462	3800157612241
Daywhite	2463	3800157612258



5730-NON WP
120 LED/M

CRI >95



Color	SKU Code	EAN Code
Warm White	2162	3800157610094
White	2163	3800157610100
Daywhite	2164	3800157610087



LED Type	5730
Watt/M	18W
Current/M	1.5A
Voltage	12V DC
LED Qty	120
LM/LED	3000
Beam Angle	120°
IP Rating	IP20
Width	8mm

5050-WP 30 LED/M



LED Type	5050	Color	SKU Code	EAN Code
Watt/M	4.8W	White	2144	3800230621399
Current/M	.4A	Warm White	2145	3800230621412
Voltage	12V	Daywhite	2460	3800157612166
LED Qty	30	Red	2129	3800230621450
LM/LED	14	Green	N/A	N/A
Beam Angle	120°	Blue	2142	3800230621436
IP Rating	IP65	Yellow	N/A	N/A
Width	10mm	RGB	2118	3800230621528

5050-NON WP 30 LED/M



LED Type	5050	Color	SKU Code	EAN Code
Watt/M	4.8W	White	2133	3800230621382
Current/M	.4A	Warm White	2135	3800230621405
Voltage	12V	Daywhite	N/A	N/A
LED Qty	30	Red	2136	3800230621443
LM/LED	12	Green	N/A	N/A
Beam Angle	120°	Blue	2127	3800230621429
IP Rating	IP20	Yellow	N/A	N/A
Width	10mm	RGB	2124	3800230621535

5050-NON WP 60 LED/M



LED Type	5050	Color	SKU Code	EAN Code
Watt/M	9.6W	White	2126	3800230621481
Current/M	.8A	Warm White	2122	3800230621504
Voltage	12V	Daywhite	2143	3800230621467
LED Qty	60	Red	2128	3800230624468
LM/LED	14	Green	2138	3800230621443
Beam Angle	120°	Blue	2137	3800230621429
IP Rating	IP20	Yellow	2156	3800230628824
Width	10mm	RGB	2120	3800230621542

5050- WP 60 LED/M



LED Type	5050	Color	SKU Code	EAN Code
Watt/M	9.6W	White	2148	3800230621498
Current/M	.8A	Warm White	2149	3800230621511
Voltage	12V	Daywhite	2150	3800230621474
LED Qty	60	Red	2152	3800230624775
LM/LED	14	Green	2153	3800230621450
Beam Angle	120°	Blue	2151	3800230621436
IP Rating	IP65	Yellow	N/A	N/A
Width	10mm	RGB	2155	3800230621559

3528-NON WP 60 LED/M



LED Type	3528	Color	SKU Code	EAN Code
Watt/M	3.6W	White	2005	3800230621153
Current/M	.3A	Warm White	2016	3800230621160
Voltage	12V	Daywhite	2041	3800230621184
LED Qty	60	Red	2015	3800230621269
LM/LED	5	Green	2011	3800230621221
Beam Angle	120°	Blue	2013	3800230621252
IP Rating	IP20	Yellow	2009	3800230621214
Width	8mm	RGB	N/A	N/A

3528-WP 60 LED/M



LED Type	3528	Color	SKU Code	EAN Code
Watt/M	3.6W	White	2031	3800230621146
Current/M	.3A	Warm White	2032	3800230621177
Voltage	12V	Daywhite	2043	3800230621191
LED Qty	60	Red	2036	3800230621276
LM/LED	5	Green	2034	3800230621238
Beam Angle	120°	Blue	2035	3800230621245
IP Rating	IP65	Yellow	2033	3800230621207
Width	8mm	RGB	N/A	N/A

3528-NON WP 120 LED/M



LED Type	3528	Color	SKU Code	EAN Code
Watt/M	7.2W	White	2002	3800230621283
Current/M	.6A	Warm White	2025	3800230621306
Voltage	12V	Daywhite	2042	3800230621320
LED Qty	120	Red	2030	3800230621368
LM/LED	5	Green	N/A	N/A
Beam Angle	120°	Blue	2029	3800230621344
IP Rating	IP20	Yellow	N/A	N/A
Width	8mm	RGB	N/A	N/A

3528-WP 120 LED/M



LED Type	3528	Color	SKU Code	EAN Code
Watt/M	7.2W	White	2037	3800230621290
Current/M	.6A	Warm White	2038	3800230621313
Voltage	12V	Daywhite	2044	3800230621337
LED Qty	120	Red	2039	3800230621375
LM/LED	5	Green	N/A	N/A
Beam Angle	120°	Blue	2027	3800230621351
IP Rating	IP65	Yellow	N/A	N/A
Width	8mm	RGB	N/A	N/A

3014-NON WP 204 LED/M



204
LED/M



IP20



LED Type	3014	Color	SKU Code	EAN Code
Watt/M	18W	White	2403	3800230628053
Current/M	1.5A	Warm White	2404	3800230628060
Voltage	12V	Daywhite	2405	3800157600309
LED Qty	204	Red	N/A	N/A
LM/LED	10LM	Green	N/A	N/A
Beam Angle	120°	Blue	N/A	N/A
IP Rating	IP20	Yellow	N/A	N/A
Width	10mm	RGB	N/A	N/A

**5050-NON WP 60 LED/M
RGB+W**

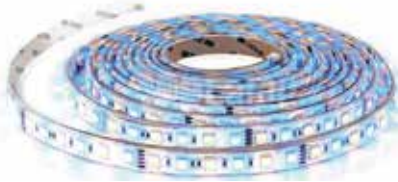

60
LED/M



IP20



LED Type	5050	Color	SKU Code	EAN Code
Watt/M	14.4W	White	N/A	N/A
Current/M	1.2A	Warm White	N/A	N/A
Voltage	12V	Daywhite	N/A	N/A
LED Qty	30:30	Red	N/A	N/A
LM/LED	15LM	Green	N/A	N/A
Beam Angle	120°	Blue	N/A	N/A
IP Rating	IP20	Yellow	N/A	N/A
Width	10mm	RGB	2159(RGB+W)	3800230629623





INTRODUCING

LED NEON FLEX

LED NEON STRIP LIGHT



MODEL	VT-555	VT-555	VT-555
SKU CODE	2512	2513	2514
Color/ Temperature	White	Warmwhite	Daywhite
Lumen LM/M	320±5%	320±5%	320±5%
FPC Width MM	7.5	7.5	7.5
Power W/M	8-10W	8-10W	8-10W
Jacket Dia	9 x16.5 mm	9 x16.5 mm	9 x16.5 mm
EAN CODE	3800157605656	3800157605663	3800157605670

⚡ DC24V Voltage

💡 120 LED PCS/M

10M ROLL

10M ROLL

💡 120 LED PCS/M

⚡ DC24V Voltage

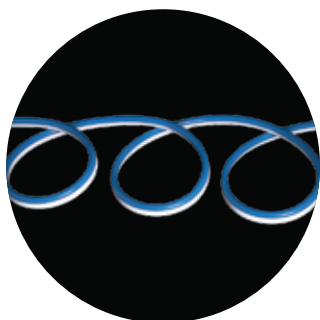

MODEL	VT-555
SKU CODE	2515
Color/ Temperature	Blue
Lumen LM/M	320±5%
FPC Width MM	7.5
Power W/M	8-10
Jacket Dia	9 x16.5 mm
EAN CODE	3800157605687

10M ROLL

💡 120 LED PCS/M

⚡ DC24V Voltage



MODEL	VT-555
SKU CODE	2516
Color/ Temperature	RED
Lumen LM/M	320±5%
FPC Width MM	7.5
Power W/M	8-10
Jacket Dia	9 x16.5 mm
EAN CODE	3800157605694



6PCS INCLUDED



Item	Profile
SKU CODE	2527

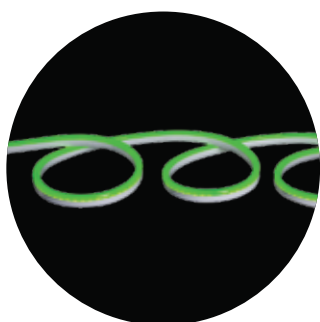

10M ROLL

⚡ DC24V Voltage

💡 120 LED PCS/M

MODEL	VT-555
SKU CODE	2517
Color/ Temperature	Green
Lumen LM/M	320±5%
FPC Width MM	7.5
Power W/M	8-10
Jacket Dia	9 x16.5 mm
EAN CODE	3800157605700

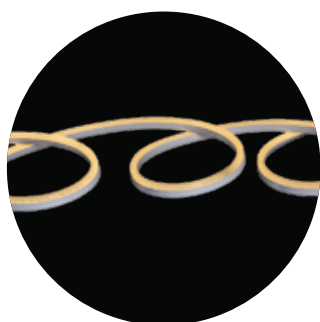

10M ROLL

⚡ DC24V Voltage

💡 120 LED PCS/M

MODEL	VT-555
SKU CODE	2518
Color/ Temperature	Yellow
Lumen LM/M	320±5%
FPC Width MM	7.5
Power W/M	8-10
Jacket Dia	9 x16.5 mm
EAN CODE	3800157605717



Item	Power cord without plug
SKU CODE	3331
EAN CODE	3800157608268



Item	Pin
SKU CODE	3333
EAN CODE	3800157607889



Item	End safe cap
SKU CODE	3334
EAN CODE	3800157607896

LED STRIP SETS PLUG AND PLAY



LED STRIP LIGHT set is a complete kit where we provide you with 5 meters of LED STRIP LIGHT ,along with the POWER SUPPLY and CONNECTOR and REMOTE CONTROL (optional) ,to make it a complete kit . Available and made in different colour options as per requirement.

- LED Strip
- Remote control (included)
- Driver (included)
- Packing: Blister Pack, 5 meters roll

SKU CODE	DESCRIPTION	EAN CODE
2351	LED Strip Set SMD3528 60 LEDs 4500K IP20	3800230621634
2350	LED Strip Set SMD5050 30 LEDs RGB IP20	3800230621641
2352	LED Strip Set SMD5050 30 LEDs RGB IP65	3800230621658
2353	LED Strip Set SMD5050 60 LEDs RGB IP20	3800230621665
2354	LED Strip Set SMD5050 60 LEDs RGB IP65	3800230621672
2355	LED Strip Set SMD5050 60 LEDs White IP20	3800230621689
2356	LED Strip Set SMD5050 60 LEDs White IP65	3800230621696

LED STRIP ACCESSORIES

SKU CODE	DESCRIPTION	EAN CODE
3500	Flexible Connector - LED Strip 3528	3800230622051
3501	Flexible Connector - LED Strip 5050	3800230622068
3502	Flexible Connector - LED Strip 5050 RGB	3800230622075
3503	Connector - LED Strip 3528	3800230622082
3504	Connector - LED Strip 5050	3800230622099
3505	Connector - LED Strip 5050 RGB	3800230622105
3507	Flexible Connector - LED Strip 3528 DC Female	N/A
3508	Flexible Connector - LED Strip 5050 DC Female	N/A
3509	Connector - LED Strip 3528 Cross Type	N/A
3510	Connector - LED Strip 5050 Cross Type	N/A
3511	Connector - LED Strip 5050 L Type	N/A
3512	Connector - LED Strip DC Female	3800230622112



**ALUMINIUM PROFILES
 FOR LED STRIPS**

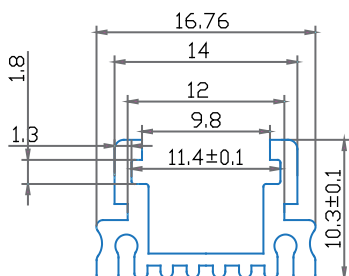
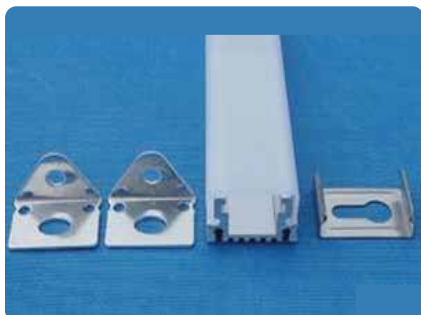

MODEL NO:	VT-7101
SKU CODE:	9981
SIZE:	16.76 x 10.3 x 1000 mm
COLOR:	Transparent
EAN CODE:	3800230622129

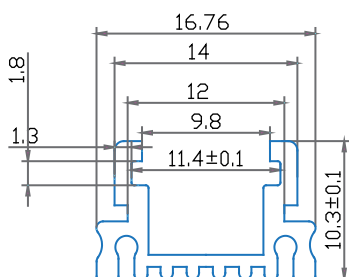
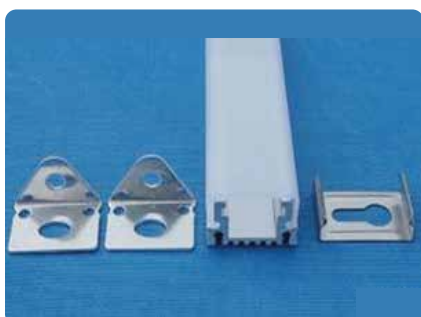

MODEL NO:	VT-7101
SKU CODE:	9982
SIZE:	16.76 x 10.3 x 1000 mm
COLOR:	Matt
EAN CODE:	3800230622136

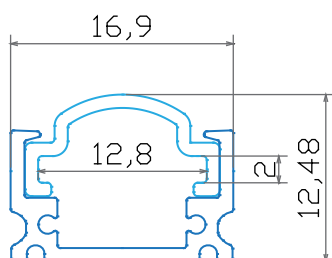

MODEL NO:	VT-7102
SKU CODE:	9983
SIZE:	16.9 x 12.48 x 1000 mm
COLOR:	Transparent
EAN CODE:	3800230622143

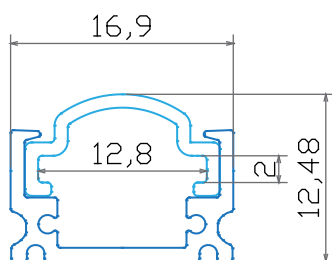

MODEL NO:	VT-7102
SKU CODE:	9984
SIZE:	16.9 x 12.48 x 1000 mm
COLOR:	Matt
EAN CODE:	3800230622150

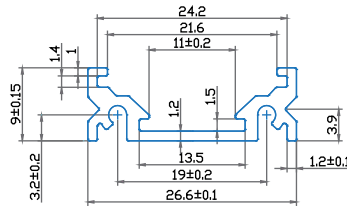

MODEL NO:	VT-7103
SKU CODE:	9985
SIZE:	26.5 x 9 x 1000 mm
COLOR:	Transparent
EAN CODE:	3800230622167

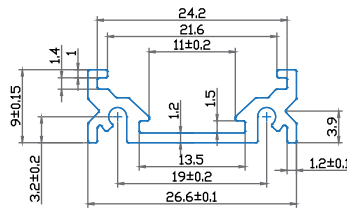

MODEL NO:	VT-7103
SKU CODE:	9986
SIZE:	26.5 x 9 x 1000 mm
COLOR:	Matt
EAN CODE:	3800230622174

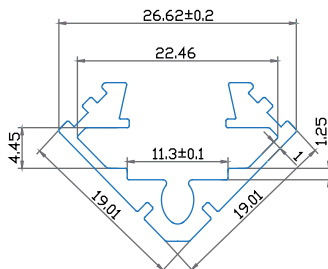
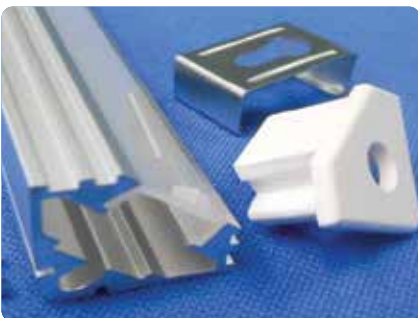

MODEL NO:	VT-7104
SKU CODE:	9987
SIZE:	19 x 19 x 1000 mm
COLOR:	Matt
EAN CODE:	3800230622181

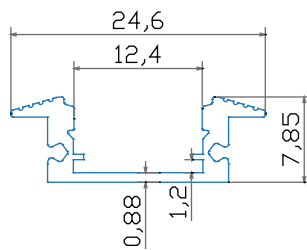

MODEL NO:	VT-7105
SKU CODE:	9990
SIZE:	24.6 x 7.85 x 1000 mm
COLOR:	Milky
EAN CODE:	3800230628077

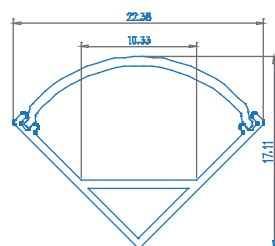
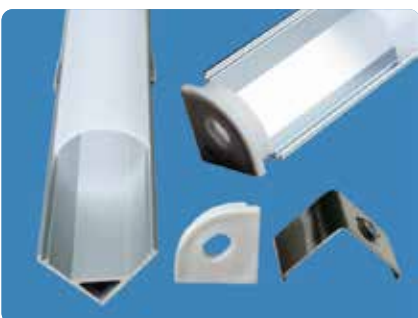

MODEL NO:	VT-7109
SKU CODE:	9947
SIZE:	22.38 x 10.33 x 17.11 mm
COLOR:	Milky
EAN CODE:	3800157617208

ALUMINIUM PROFILES FOR LED STRIPS

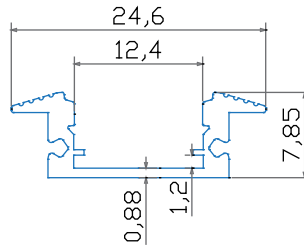

MODEL NO:	VT-7105
SKU CODE:	9991
SIZE:	24.6 x 7.85 x 2000 mm
COLOR:	Milky
EAN CODE:	3800230628794

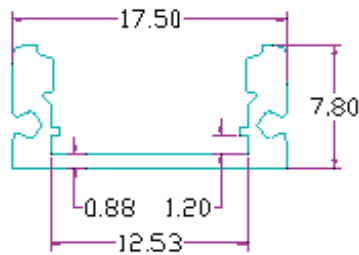
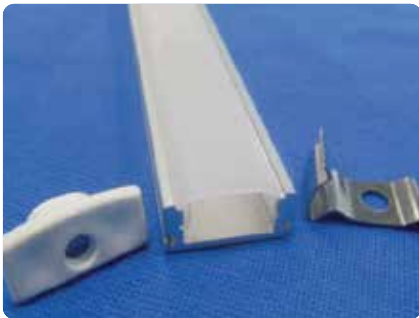

MODEL NO:	VT-7106
SKU CODE:	9992 /9993
SIZE:	17.5 x 7.8 x1000 / 2000 mm
COLOR:	Milky / Milky
EAN CODE:	3800230628800 3800230628817

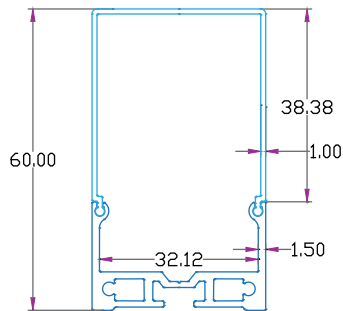
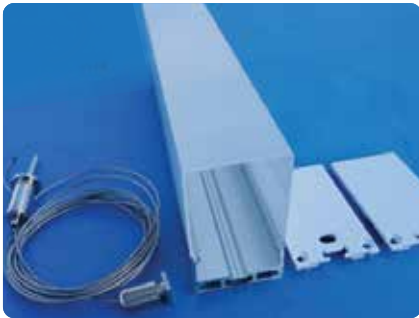

MODEL NO:	VT-7107
SKU CODE:	9994
SIZE:	60 x 35.1 x 1000 mm
COLOR:	Milky
EAN CODE:	3800157601399

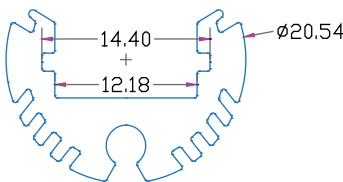

MODEL NO:	VT-7108
SKU CODE:	9995
SIZE:	ø20.54 x 1000 mm
COLOR:	Milky
EAN CODE:	3800157601405

LED STRIP CONTROLLERS



DC12/24V
Voltage

SKU Code	3300
Model No.	VT-2402
Description	Dimmer for LED Strip with Remote Control
Max Current /Watt	8A, 96W
Input Voltage	DC 12/24 V
Size	115 x 55 x 35 mm
EAN Code	3800230622198



DC12/24V
Voltage

SKU Code	3303
Model No.	VT-2404
Description	Radio Controller with Remote Control 4 Buttons
Max Current /Watt	12A, 144W
Input Voltage	DC 12/24 V
Size	105 x 65 x 20 mm
EAN Code	3800230622204



INFRARED
REMOTE
CONTROL DC12/24V
Voltage

SKU Code	3304
Model No.	VT-2401
Description	Infrared Controller with Remote Control 24 Buttons
Max Current /Watt	6A, 72W
Input Voltage	DC 12/24 V
Size	65 x 35 x 22 mm
EAN Code	3800230622211



DC12V
Voltage

SKU Code	3307
Model No.	VT- DMX 512
Description	DMX 512 Controller
Max Current /Watt	4A x3, 144W
Input Voltage	DC 12V
Size	165 x 75 x 25 mm
EAN Code	3800230622266



DC12/24V
Voltage

SKU Code	3312
Model No.	VT-2405
Description	Radio Controller with Touch Remote Control
Max Current /Watt	3A x4, 144W
Input Voltage	DC 12/24 V
Size	130 x 65 x 25 mm
EAN Code	3800230622273



SKU Code	3317
Model No.	VT-2401
Description	Infrared Controller with Remote Control 44 Buttons
Max Current /Watt	6A, 72W
Input Voltage	DC 12/24 V
Size	125 x 56 x 7 mm
EAN Code	3800230622228



SKU Code	3625
Model No.	VT-2472
Description	Infrared Controller with Remote Control 24 Buttons
Max Current /Watt	6A, 72W
Input Voltage	DC 12/24 V
Size	N/A
EAN Code	3800157609920



DC12V
Voltage

SKU Code	3318
Model No.	N/A
Description	Radio Controller with Remote Control
Max Current /Watt	500W
Input Voltage	DC 12V
Size	120 x 75 x 25 mm
EAN Code	3800230622235



RF
REMOTE
CONTROL

DC12V
Voltage

SKU Code	3320
Model No.	N/A
Description	Mini RF Controller
Max Current /Watt	N/A
Input Voltage	DC 12V
Size	N/A
EAN Code	3800230628022

LED STRIP CONTROLLERS



SKU Code	3319
Model No.	N/A
Description	24B Mini Controller
Max Current /Watt	N/A
Input Voltage	DC 12V
Size	N/A
EAN Code	3800230628015



SKU Code	3321
Model No.	N/A
Description	Wi-Fi Single Controller
Max Current /Watt	N/A
Input Voltage	DC 12V
Size	N/A
EAN Code	3800230628039



SKU Code	3322
Model No.	N/A
Description	Wi-Fi RGB Controller
Max Current /Watt	N/A
Input Voltage	DC 12V
Size	N/A
EAN Code	3800230628046



SKU Code	3326
Model No.	N/A
Description	5050 60 RGB + WHITE LED Controller
Max Current /Watt	N/A
Input Voltage	DC 12V
Size	N/A
EAN Code	3800230629630



SKU Code	3327
Model No.	VT-2408
Description	RGB+W Amplifier
Max Current /Watt	N/A
Input Voltage	DC 12V
Size	N/A
EAN Code	3800157601047



SKU Code	3328
Model No.	N/A
Description	360W RF Controller
Max Current /Watt	N/A
Input Voltage	DC 12V
Size	N/A
EAN Code	3800157601054



SKU Code	3009
Model No.	N/A
Description	5050 RGB Strip Amplifier
Max Current /Watt	N/A
Input Voltage	DC 12V
Size	N/A
EAN Code	3800230622259



SKU Code	3018
Model No.	N/A
Description	5050 RGB Strip Mini-Amplifier
Max Current /Watt	N/A
Input Voltage	DC 12V
Size	N/A
EAN Code	3800230622242

SMD LED MODULES



⚡ DC12V Voltage

Model No.	VT-50503
Sku Code	White: 5116 Red: 5117 Blue: 5118 Green: 5119.
Watts	0.72W/PC
Lumens	66lm/PC
Beam Angle	160°D
Cri	75
Voltage /frqncy	DC 12V
Unit Size	67x15x8.5mm
Ip Rating	IP67
Material	ABS+PCB



⚡ DC12V Voltage

Model No.	VT-28353
Sku Code	White: 5120 Red: 5121 Blue: 5122 Green: 5123
Watts	1W/PC
Lumens	100lm/PC
Beam Angle	120°D
Cri	75
Voltage /frqncy	DC 12V
Unit Size	53x12x4.6mm
Ip Rating	IP65
Material	ABS+Aluminum plate

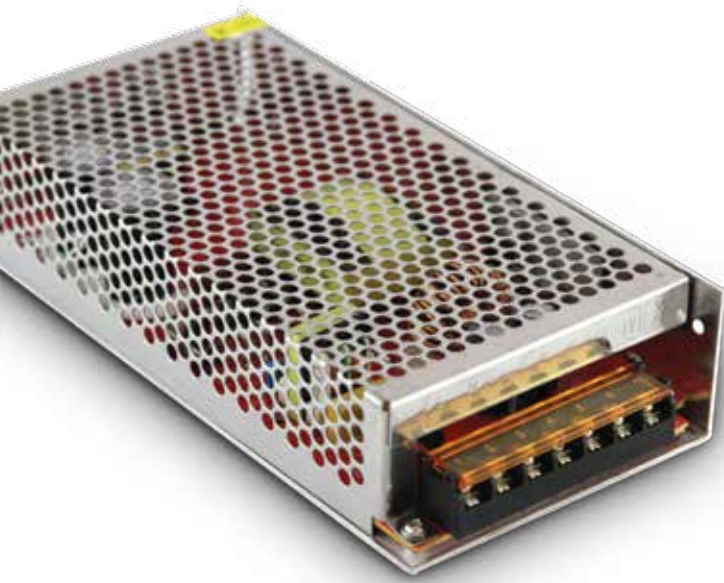

LED STRIP POWER SUPPLY METAL DRIVER (SMPS) SERIES

Product Features :

- Switching Metal Power Supply for all types of strip lights, led lighting , led display , etc
- With short circuit protection, over load protection , stable output voltage
- Built in EMI Filter
- High efficiency , low temperature
- 100% load tested
- Protection Rating : IP20
- CE, ROHS, EMC approved

MODEL	SKU CODE	WATTS POWER	CURRENT CAPACITY	OUTPUT	UNIT SIZE	EAN CODE
VT-20025	3050	25W	2.1A	12V	90 x 60 x 40 mm	3800230621726
VT-20040	3058	40W	3.3A	12V	108 x 78 x 35 mm	3800230625731
VT-20045	3051	45W	3.8A	12V	110 x 78 x 35 mm	3800230621733
VT-20060	3052	60W	5A	12V	160 x 98 x 38 mm	3800230621740
VT-20075	3053	75W	6A	12V	160 x 98 x 38 mm	3800230621757
VT-20080	3059	80W	6.6A	12V	160 x 98 x 40 mm	3800230625748
VT-20100	3060	100W	8.3A	12V	199 x 98 x 42 mm	3800230625755
VT-20120	3054	120W	10A	12V	199 x 98 x 42 mm	3800230621764
VT-20150	3055	150W	12.5A	12V	199 x 98 x 42 mm	3800230621771
VT-20200	3061	200W	16.5A	12V	200 x 110 x 50 mm	3800230625762
VT-20250	3056	250W	20A	12V	200 x 110 x 50 mm	3800230621788
VT-20350	3057	350W	30A	12V	215 x 115 x 50 mm	3800230621795
VT-20500	3062	500W	42A	12V	215 x 115 x 50 mm	3800157605984

LED STRIP POWER SUPPLY

RAINPROOF POWER SUPPLY SERIES

Product Features :

- RAIN PROOF DRIVER for all types of STRIP LIGHTS, LED LIGHTING, LED DISPLAY, etc.
- Industrial specifications and standards.
- With short circuit protection, over load protection and stable output voltage.
- Built in EMI Filter.
- High efficiency and low temperature.
- 100% load tested.
- Protection Rating: IP23
- CE, ROHS and EMC approved.



MODEL	SKU CODE	WATTS POWER	CURRENT CAPACITY	OUTPUT	UNIT SIZE	EAN CODE
VT-21060	3070	60W	5A	12V	155 x 105 x 50 mm	3800230621801
VT-21080	3069	80W	6.6A	12V	155 x 105 x 50 mm	3800230621818
VT-21080	3075	80W	3.3A	24V	155 x 102 x 46 mm	3800230621870
VT-21120	3071	120W	10A	12V	195 x 115 x 53 mm	3800230621825
VT-21150	3072	150W	12.5A	12V	195 x 115 x 53 mm	3800230621832
VT-21150	3076	150W	6.2A	24V	195 x 112 x 52 mm	3800230621880
VT-21200	3078	200W	8.3A	24V	195 x 112 x 50 mm	3800230621849
VT-21250	3073	250W	20A	12V	233 x 153 x 66 mm	3800230621856
VT-21300	3081	300W	25A	12V	233 x 153 x 66 mm	3800157601542
VT-21400	3074	400W	33A	12V	233 x 153 x 66 mm	3800230621863
VT-21400	3077	400W	16.6A	24V	232 x 153 x 65 mm	3800230621894



LED STRIP POWER SUPPLY WATERPROOF POWER SUPPLY SERIES

Product Features:

- WATERPROOF DRIVER for all types of STRIP LIGHTS, LED LIGHTING, LED DISPLAY, etc.
- Industrial specifications and standards.
- With short circuit protection, over load protection and stable output voltage.
- Built in EMI Filter.
- High efficiency and low temperature.
- 100% load tested.
- Protection Rating: IP65.
- CE, ROHS, EMC approved.



MODEL	SKU CODE	WATTS POWER	CURRENT CAPACITY	OUTPUT	UNIT SIZE	EAN CODE
VT-22030	3100	30W	2.5A	12V	201 x 30.5 x 20 mm	3800230621900
VT-22045	3090	45W	3.75A	12V	250 x 40 x 23 mm	3800230621917
VT-22045	3095	45W	1.88A	24V	250 x 40 x 23 mm	3800230621979
VT-22060	3091	60W	5A	12V	180 x 72 x 45 mm	3800230621924
VT-22100	3092	100W	8.5A	12V	253 x 72 x 45 mm	3800230621931
VT-22120	3093	120W	10A	12V	253 x 72 x 45 mm	3800230621948
VT-22150	3094	150W	12.5A	12V	253 x 72 x 45 mm	3800230621955
VT-22150	3096	150W	6.25A	24V	253 x 72 x 45 mm	3800230621986
VT-22200	3097	200W	8.3A	24V	231 x 120 x 53 mm	3800230621993
VT-22200	3098	200W	16.6A	12V	200 x 120 x 53 mm	3800230625779
VT-22360	3099	360W	30A	12V	256 x 102 x 65 mm	3800230625786
VT-22020	3214	20W	0.83A	24V	201 x 30.5 x 20 mm	3800230621962
VT-22030	3215	30W	1.25A	24V	201 x 30.5 x 20 mm	3800230629562
VT-22101	3101	100W	4.2A	24V	201 x 30.5 x 20 mm	3800157605991
VT-22300	3219	300W	25A	12V	201 x 30.5 x 20 mm	3800157604932

LED STRIP POWER SUPPLY PLASTIC ADAPTOR SERIES

Product Features :



- Plastic DRIVER for all types of STRIP LIGHTS, LED LIGHTING, LED DISPLAY, etc.
- With specifications and Industrial standards.
- With short circuit protection, over load protection and stable output voltage.
- Built in EMI Filter.
- High efficiency and low temperature.
- 100% load tested.
- Protection Rating: IP 20.
- CE, Rosh, EMC approved.
- Options available with BS STANDARD 3 PIN PLUG.

MODEL	SKU CODE	WATTS POWER	CURRENT CAPACITY	OUTPUT	VOLTAGE / FREQUENCY	EAN CODE
VT-23018	3017	18W	1.5A	12V	AC 110-240V, 50/60Hz	3800230622006
VT-23030	3007	30W	2.5A	12V	AC 110-240V, 50/60Hz	3800230622013
VT-23042	3016	42W	3.5A	12V	AC 110-240V, 50/60Hz	3800230622020
VT-23060	3008	60W	5A	12V	AC 110-240V, 50/60Hz	3800230622037
VT-23080	3019	78W	6.5A	12V	AC 110-240V, 50/60Hz	3800230622044
VT-23040	3033	40W	3.3A	12V	AC 110-240V, 50/60Hz	3800230626745
VT-23002 W <small>With UK Standard, BS plug</small>	3030	24W	2A	12V	AC 85-240V, 50/60Hz	3800230625298
VT-23003 W <small>With UK Standard, BS plug</small>	3031	42W	3.5A	12V	AC 85-240V, 50/60Hz	3800230625304
VT-23005 W <small>With UK Standard, BS plug</small>	3032	60W	5A	12V	AC 85-240V, 50/60Hz	3800230625311



Plastic Adaptor Series (EMC Approved)



MODEL	SKU CODE	WATTS POWER	CURRENT CAPACITY	OUTPUT	VOLTAGE / FREQUENCY	EAN CODE
VT-23024	3036	24W	2A	12V	AC: 110-240V, 50/60Hz	3800157601474
VT-23060	3035	60W	5A	12V	AC: 110-240V, 50/60Hz	3800157601085
VT-23078	3034	78W	6.5A	12V	AC: 110-240V, 50/60Hz	3800157601078
VT-23024 W <small>With UK Standard, BS plug</small>	3038	24W	2A	12V	AC: 110-240V, 50/60Hz	3800157601535
VT-23060 W <small>With UK Standard, BS plug</small>	3037	60W	5A	12V	AC: 110-240V, 50/60Hz	3800157601528